

Automotive Relays
CQ RELAYS

Product Catalog

**IN Your
Future**

CQ RELAYS

1 Form C Automotive Quiet Relay

[Protective construction] Sealed

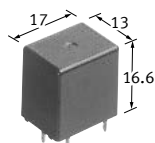

(Unit: mm)

FEATURES

- Sound pressure reduced by approx. 20 dB from that of the conventional non-quiet relays.
- Space saving.
- Adopting standard terminal pitch (for compact relays).
- Wiper load models are listed.

TYPICAL APPLICATIONS

- For intermittent wipers and applications requiring quiet operation.

ORDERING INFORMATION (PART NO.)

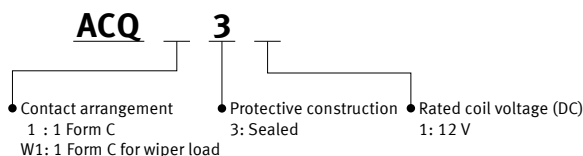

TYPES

Contact arrangement	Rated coil voltage	Part No.	Packing	
			Carton (1-tube)	Case
1 Form C	12 V DC	ACQ131	40 pcs.	800 pcs.
1 Form C for wiper load		ACQW131		

RATING

Coil data

Rated coil voltage	Operate voltage (at 20°C) (Initial)	Release voltage (at 20°C) (Initial)	Rated operating current [±10%] (at 20°C)	Coil resistance [±10%] (at 20°C)	Rated operating power (at 20°C)	Usable voltage range
12 V DC	Max. 7.2 V DC	Min. 1.0 V DC	53.3 mA	225 Ω	640 mW	10 to 16 V DC

Note: Other operate voltage types are also available. Please inquire our sales representative for details.

Automotive Relays CQ RELAYS

Specifications

1) Standard CQ relay

Item		Specifications
Contact data	Contact arrangement	1 Form C
	Contact resistance (initial)	Max. 100 mΩ (N.O. side: typ. 7 mΩ, N.C. side: typ. 8 mΩ) (By voltage drop 1 A 6 V DC)
	Contact voltage drop (initial)	Max. 0.2 V (at 10 A 12 V DC)
	Contact material	Ag alloy
	Rated switching capacity (resistive)	N.O. side: 20 A 14 V DC, N.C. side: 10 A 14 V DC
	Max. carrying current *1 *4	N.O. side: 35 A/2 min, 25 A/1 hour (Coil applied voltage 12 V DC, at 20°C) 30 A/2 min, 20 A/1 hour (Coil applied voltage 12 V DC, at 85°C)
	Min. switching load (resistive)*2	1 A 14 V DC (at 20°C)
Insulated resistance (initial)		Min. 100 MΩ (at 500 V DC, Measurement at same location as "Dielectric strength" section.)
Dielectric strength (initial)	Between open contacts	500 Vrms for 1 min (Detection current: 10 mA)
	Between contacts and coil	500 Vrms for 1 min (Detection current: 10 mA)
Time characteristics (initial)	Operate time (at rated voltage)	Max. 10 ms (at 20°C, without contact bounce time)
	Release time (at rated voltage)	Max. 10 ms (at 20°C, without contact bounce time) (without diode)
Shock resistance	Functional	Min. 100 m/s ² (Half-wave pulse of sine wave: 11 ms, detection time: 10 μs)
	Destructive	Min. 1,000 m/s ² (Half-wave pulse of sine wave: 6 ms)
Vibration resistance	Functional	10 to 100 Hz, Min. 44.1 m/s ² (Detection time: 10 μs)
	Destructive	10 to 500 Hz, Min. 44.1 m/s ² Time of vibration for each direction; X, Y direction: 2 hours, Z direction: 4 hours
Expected life	Mechanical	Min. 10 x 10 ⁵ (at 120 times/min)
	Electrical *4	<Resistive load> Min. 10 ⁵ (at rated switching capacity, operating frequency: 1 s ON, 9 s OFF) <Motor load> N.O. side: Min. 3 x 10 ⁵ (inrush 30 A, steady 5 A, 20 A 14 V DC at break current) (operating frequency: 1 s ON, 2 s OFF)
Conditions	Conditions for usage, transport and storage *3	Ambient temperature: -40 to +85°C, Humidity: 5 to 85% RH (Avoid icing and condensation)
Weight		Approx. 6.5 g

Notes: *1.Depends on connection conditions. Also, this does not guarantee repeated switching. We recommend that you confirm operation under actual conditions.

*2.This value can change due to the switching frequency, environmental conditions, and desired reliability level, therefore it is recommended to check this with the actual load.

*3.The upper operation ambient temperature limit is the maximum temperature that can satisfy the coil temperature rise value. For details, please refer to the "Automotive Relay Users Guide".

*4.For wiper motor load, please see the wiper load specifications, below.

2) For wiper load (ACQW131)

Anything outside of that given below complies with standard CQ relays.

Item		Specifications
Contact data	Max. carrying current (initial)*1	N.O. side: 25 A/1 min, 15 A/1 hour (coil applied voltage 12 V DC, at 20°C)
Expected life	Electrical life	<Wiper motor load (L = approx. 1 mH, without capacitor)> N.O. side: Min. 500 x 10 ³ (inrush 25 A, steady 6 A 14 V DC) N.C. side: Min. 500 x 10 ³ (12 A 14 V DC at brake current) (operating frequency: 1 s ON, 9 s OFF)

Note: *1.Depends on connection conditions. Also, this does not guarantee repeated switching. We recommend that you confirm operation under actual conditions.

REFERENCE DATA

1.Max. switching capability (Resistive load, initial)

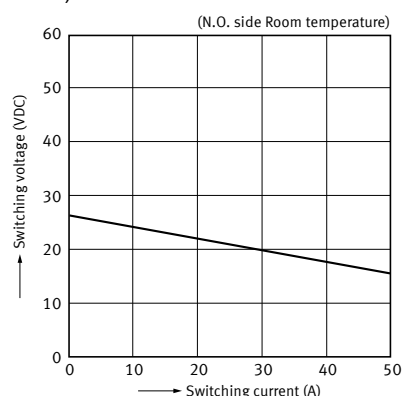

2.Ambient temperature and usable voltage range

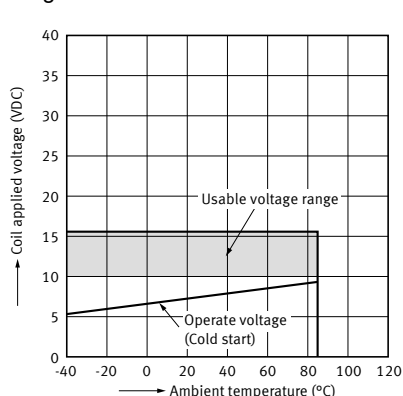

3.Ambient temperature characteristics

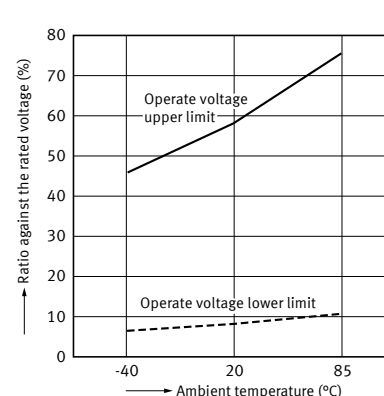

4. Distribution of operate and release voltage

Sample: ACQ131, 100 pcs

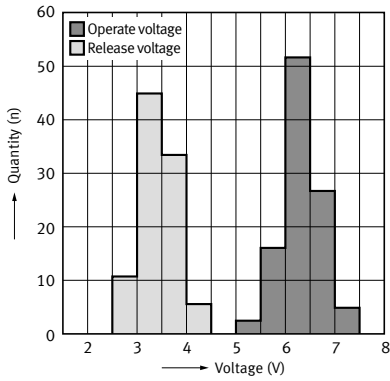

5. Distribution of operate time

Sample: ACQ131, 100 pcs

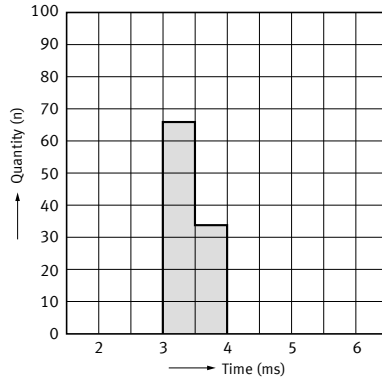

6. Distribution of release time

Sample: ACQ131, 100 pcs

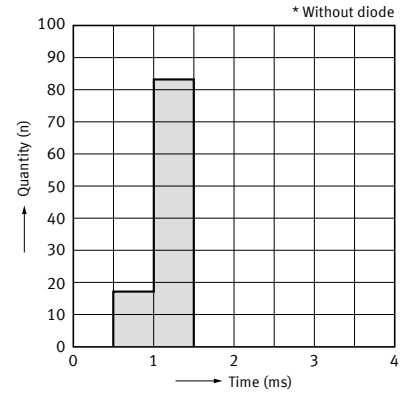

7. Electrical life test for wiper load (Motor free)

Sample: ACQW131
 Quantity: n = 3
 Load: N.O. side: Inrush 25 A, steady 6 A 14 V DC
 N.C. side: Brake current 12 A 14 V DC
 Operating frequency: ON 1 s, OFF 9 s
 Ambient temperature: Room temperature
 Circuit:

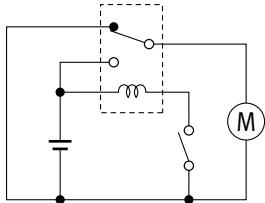

Change of operate and release voltage

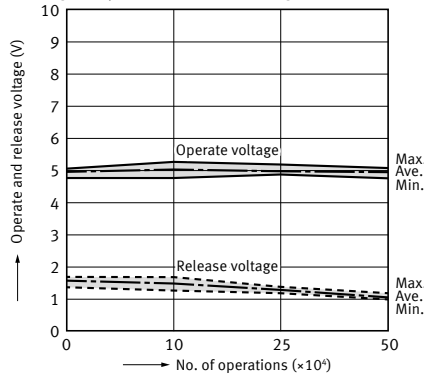

Change of contact resistance

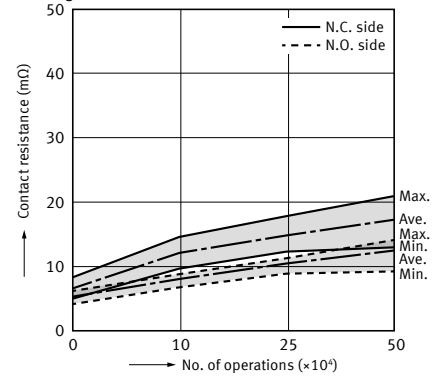

8-1. Operation noise distribution

When operate

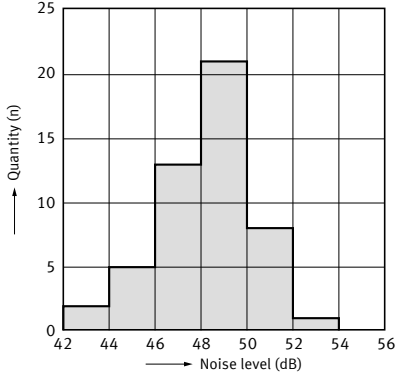

8-2. Operation noise distribution

When release

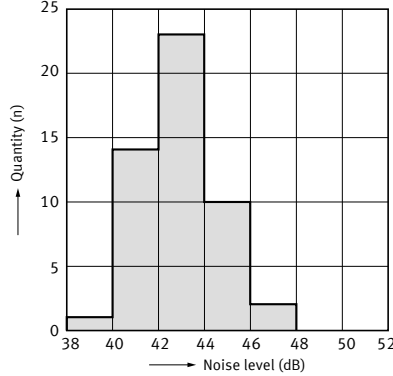

Measuring conditions
 Sample: ACQ131, 50 pcs.
 Equipment setting: "A" weighted, Fast, Max. hold
 Coil voltage: 12 V DC
 Coil connection device: Diode
 Background noise: Approx. 20 dB

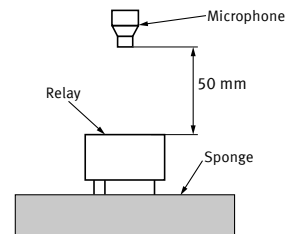

DIMENSIONS

CAD The CAD data of the products with a "CAD" mark can be downloaded from our Website.

Unit: mm

CAD



External dimensions

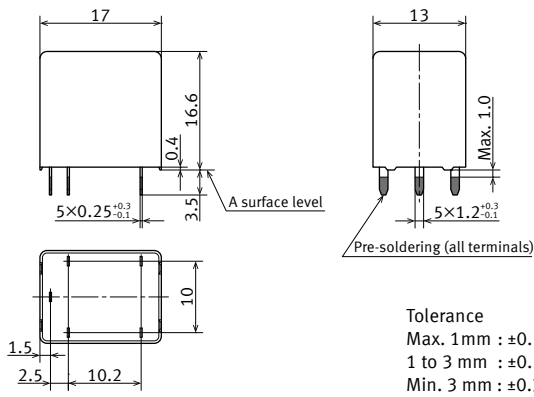

* Dimensions (thickness and width) of terminal is measured before pre-soldering. Intervals between terminals is measured at A surface level.

PC board pattern (BOTTOM VIEW)

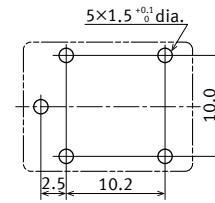

Schematic (BOTTOM VIEW)

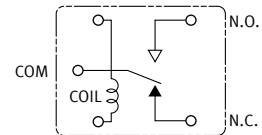

GUIDELINES FOR USAGE

■ For general cautions for use, please refer to the "Automotive Relay Users Guide".

Please refer to **"the latest product specifications"** when designing your product.

•Requests to customers:

<https://industrial.panasonic.com/ac/e/salespolicies/>

Panasonic
INDUSTRY

Panasonic Industry Co., Ltd.

Electromechanical Control Business Division
■1006, Oaza Kadoma, Kadoma-shi, Osaka 571-8506, Japan
industrial.panasonic.com/ac/e/